

TECHNICAL DATASHEET

5W Fixed Blade USB Charger – US



Applications

- Smart Phones
- PDAs
- Personal Electronics
- Digital Cameras

Features

- Fixed Blade
- Halogen Free
- Low Profile
- Low Cost
- No Y Caps
- US DoE Level VI Compliance
- No Load Power Draw <0.03W
- Charging scheme: Divider Mode
Charging (2.7V to Pin2, 2V to Pin3)

Safety Standards



Dimensions

42 x 43 x 21 mm

(1.65 x 1.69 x 0.83 inch)

Specification¹

	Model	PSA05A-050QL6-H	PSA05A-050QL6W-H ²
Output	DC Output Voltage	5.0V	
	Max Current	1.0A	
	Output Power	5.0W	
	Regulation	± 5%	
	Ripple & Noise P-P(max) ³	200mV	
Input	AC Input Voltage Range	90 to 264VAC	
	AC Input Frequency	47 to 63Hz	
	Input Current	0.15A(RMS) max	
	No Load Power Consumption at 115VAC Input	≤0.1W	
	No Load Power Consumption at 230VAC Input	≤0.075W	
	115VAC Average Efficiency ⁴	≥73.6%	
	230VAC Average Efficiency ⁴	≥73.8%	
	Leakage Current	5uA max	
Protection	Over-Voltage	10.0V max	
	Short Circuit	Auto restart	
Environmental	Operating Temperature	0°C to +40°C	
	Non-Operating Temperature	-40° to +85°C	
	Operating Humidity	90% RH max	
Safety Approvals and EMC	Dielectric Withstand (HI-POT)	Primary to Secondary: 3000VAC for 1min, 10mA	
	Insulation Resistance	Primary to Secondary: 10M ohm for 500VDC	
	Standards	cULus 62368-1, PSE, BSMI	
	EMI Emissions	FCC Part 15 Class B, CAN ICES-003(B)/NMB-003(B), EN 55032/CISPR 32 Class B Conducted and Radiated	
	Harmonic Current Emissions	IEC 61000-3-2	
	Voltage Fluctuations & Flicker	IEC 61000-3-3	
	Immunity	EN 55024/CISPR 24: IEC 61000-4-2 (Contact:+/- 4KV, Air:+/- 8KV), IEC 61000-4-3, IEC 61000-4-4, IEC 61000-4-5 (+/- 1kV), IEC 61000-4-6, IEC 61000-4-8, IEC 61000-4-11	
Mechanical	Dimensions (L x W x H)	42.0mm (1.65in) x 43.0mm (1.69in) x 21.0mm (0.83in)	
	DC Output Connector	USB-A	
	Case Color	Black	White
Notes	<ol style="list-style-type: none"> The specifications defined are at ambient temperature of 25C, unless otherwise specified. Special order item. Minimum order quantity applies. 20MHz bandwidth frequency oscilloscope, add a 0.1μF multilayer Cap. and Low ESR Electrolytic Cap. (10μF) at output connector terminals (nominal line voltage, full load). Efficiency is measured after 30 minutes burn-in. 		

Phihong is not responsible for any error and reserves the right to make changes without notice. Please visit our website at www.phihong.com for the most up-to-date specifications and contact information.

Dimensional Diagram Unit: mm

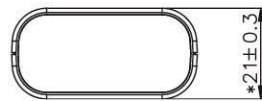
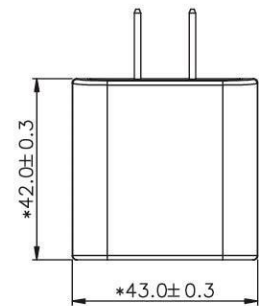
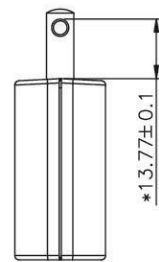
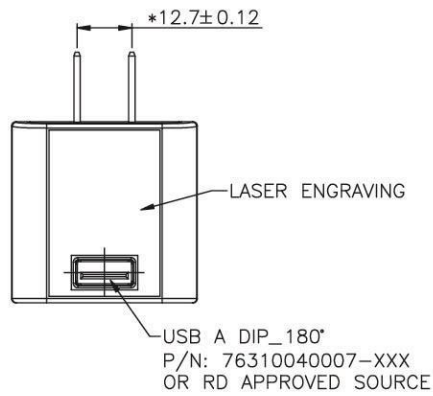
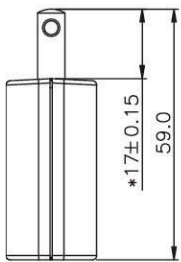
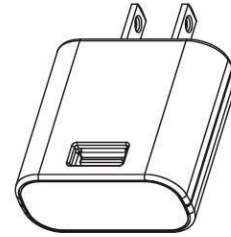
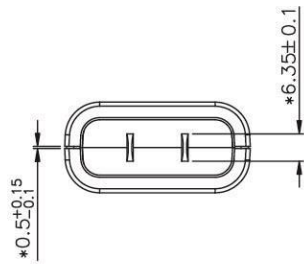

USB Cables - Sold Separately Unit: mm

Part no: IP-USB1(C10)S	Desc: USB-A to Micro-B - 1 Meter - Black
Part no: IPUSB1CS	Desc: USB to Mini-B - 1.5 Meter - Black
Part no: IPUSB1MS	Desc: USB-A to Micro-B - 1.5 Meter - Black
Part no: IPUSB1M5LD	Desc: USB-A to Micro-B - 24AWG - Low Drop - 1.5 Meter - Black
Part no: IPUSB1P5	Desc: USB-A to Micro-B - 1 Meter - 24AWG - Black
Part no: IPUSB1P5W	Desc: USB-A to Micro-B - 1 Meter - 24AWG - White
Part no: IPUSB1MSW	Desc: USB-A to Micro-B - 1.5 Meter - White

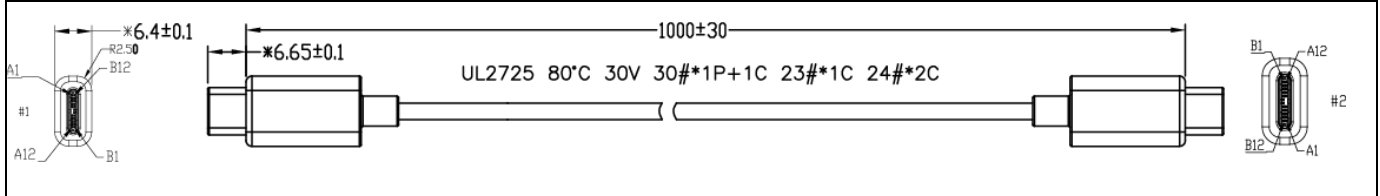
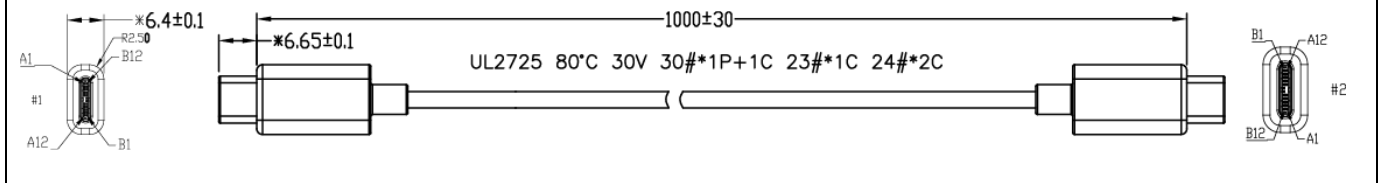
Part no: UES-1001A160	Desc: Low Drop Type-C USB Cable - 1 Meter - 23AWG on Power - 30AWG on Data - Black
	
Part no: UES-1003A160	Desc: Low Drop Type-C USB Cable - 1 Meter - 23AWG on Power - 30AWG on Data - White
	

Phihong Locations



Headquarters Phihong Technology Co., Ltd
No. 568, Fuxing 3rd Rd., Gueishan Dist., Taoyuan City (33383), Taiwan
Tel : +886-3-3277288
Fax : +886-3-3277622
phsales@phihong.com.tw
www.phihong.com.tw



Phihong Technology Co. Ltd. (Tainan R&D Center)
No. 99, Zhengnan 1st. Street, Yongkang Dist., Tainan City 71046, Taiwan
Tel : +886-6-254-7588
Fax : +886-6-254-7288
phsales@phihong.com.tw
www.phihong.com.tw



Phihong China
Room 101, Building 5, 133-1 Tiesong Road, Qingxi Town, Dong Guan City, Guangdong (523642), China
Tel : +86-769-87736405
phsales@phihong.com.tw



Phihong USA
47800 Fremont Blvd., Fremont, CA 94538, U.S.A.
Tel : +1-510-445-0100
Fax : +1-510-445-1678
usasales@phihongusa.com
www.phihong.com

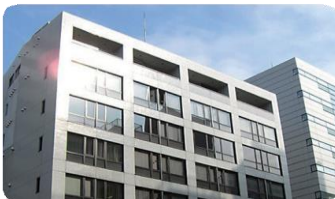

Phihong Japan
PMOEX Nihonbashi Kayabacho 10F, 2-12-10
Nihonbashi Kayabacho, Chuo City, Tokyo 103-0025 Japan
Tel : +81-3-6626-5513
Fax : +81-3-6629-0241
phsales@phihong.com.tw
www.phihong.co.jp



Phihong Vietnam
Lot CN5 An Duong Industrial Zone, Hong Phong Commune, An Duong County, Hai Phong City, Vietnam
Tel : +84-22588-31557