

TECHNICAL DATASHEET

20-30W Desktop C14 Adapter Series



Applications

- Portable Equipment
- Gaming Machines
- Peripherals
- Networking

Features

- Non-Vented Case
- US DoE Level VI Efficiency Compliance
- Ecodesign/ErP Lot 7 (EU) 2019/1782 Compliance
- Class B EMI

Safety Standards



Dimensions

103.4 x 42 x 10.0 mm
(4.07 x 1.65 x 1.13 inch)

Weight

175g

*NRCan approval for PSAC30U-120L6-R,
PSAC30U-240L6-R models only

Specification¹

Model		PSAC30U-090L6-R ²	*PSAC30U-120L6-R ²
Output	DC Output Voltage	9.0V	12.0V
	Max Current	3.0A	2.5A
	Output Power	27.0W	30.0W
	Regulation	± 5%	± 5%
	Ripple & Noise P-P(max) ²	90mV	120mV
Input	AC Input Voltage Range	90 to 264VAC	
	AC Input Frequency	47 to 63Hz	
	Input Current	0.8A (RMS) max @120VAC, 0.5A (RMS) max @240VAC	
	Inrush Current	60A max @100VAC, 100A max @240VAC	
	No Load Power Consumption at 115VAC Input	0.030W	0.0264W
	No Load Power Consumption at 230VAC Input	0.060W	0.054W
	115VAC Average Efficiency ³	87.98%	88.88%
	230VAC Average Efficiency ³	87.63%	88.83%
	230VAC 10% Load Efficiency ³	82.30%	83.98%
	Leakage Current	3.5mA max @254VAC, 50Hz	
Protection	Over-Voltage	15V max, Auto-restart	20V max, Auto-restart
	Short Circuit	Output can be shorted permanently without damage	
	Over-Current	Auto restart	
Environmental	Operating Temperature	0°C to +40°C	
	Non-Operating Temperature	-20° to +75°C	
	Operating Humidity	20 to +90%	
Safety Approvals and EMC	Dielectric Withstand (HI-POT)	Primary to Secondary: 3000VAC for 1min, 10mA	
	Insulation Resistance	Primary to Secondary: >7M ohm for 500VDC	
	Standards	cULus 60950-1, cULus 62368-1 IEC 60950-1, IEC 62368-1	
	EMI Emissions	FCC Part 15 Class B, CAN ICES-003(B)/NMB-003(B), EN 55032/CISPR 32 Class B Conducted and Radiated	
	Harmonic Current Emissions	IEC 61000-3-2	
	Voltage Fluctuations & Flicker	IEC 61000-3-3	
	Immunity	EN 55035/CISPR 35: IEC 61000-4-2 (+/- 8kV air, +/-4kV contact), IEC 61000-4-3, IEC 61000-4-4, IEC 61000-4-5 (+/- 1kV), IEC 61000-4-6, IEC 61000-4-8, IEC 61000-4-11	
Mechanical	Dimensions (L x W x H)	103.4mm (4.07in) x 42mm (1.65in) x 28.7mm (1.13in)	
	Weight	175g	
	DC Cord Length	1000mm	1500mm
	DC Output Connector	2.1mm x 5.5mm x 10.0mm	
	DC Plug Pin Assignment	Inner (V+) / Outer GND (V-)	
	Cable Wire Type	16 AWG	18 AWG
	Input Connector	IEC 60320 C14	

Specification¹

	Model	*PSAC30U-240L6-R ²	PSAC30U-480L6-R ²	PSAC30U-560L6-R ²
Output	DC Output Voltage	24.0V	48.0V	56.0V
	Max Current	1.25A	0.625A	0.536A
	Output Power	30.0W	30.0W	30.016W
	Regulation	± 5%	± 5%	± 5%
	Ripple & Noise P-P(max) ³	240mV	480mV	560mV
Input	AC Input Voltage Range	90 to 264VAC		
	AC Input Frequency	47 to 63Hz		
	Input Current	0.8A (RMS) max @120VAC, 0.5A (RMS) max @240VAC		
	Inrush Current	60A max @100VAC, 100A max @240VAC		
	No Load Power Consumption at 115VAC Input	0.042W	0.050W	0.100W
	No Load Power Consumption at 230VAC Input	0.070W	0.080W	0.090W
	115VAC Average Efficiency ⁴	89.22%	89.83%	90.27%
	230VAC Average Efficiency ⁴	89.19%	89.10%	89.18%
	230VAC 10% Load Efficiency ⁴	83.33%	78.57%	79.88%
	Leakage Current	3.5mA max @254VAC, 50Hz		
Protection	Over-Voltage	33V max, Auto-restart	65V max, Auto-restart	66V max, Auto-restart
	Short Circuit	Output can be shorted permanently without damage		
	Over-Current	Auto restart		
Environmental	Operating Temperature	0°C to +40°C		
	Non-Operating Temperature	-20° to +75°C		
	Operating Humidity	20 to +90%		
Safety Approvals and EMC	Dielectric Withstand (HI-POT)	Primary to Secondary: 3000VAC for 1min, 10mA		
	Insulation Resistance	Primary to Secondary: >7M ohm for 500VDC		
	Standards	cULus 60950-1, cULus 62368-1 IEC 60950-1, IEC 62368-1		
	EMI Emissions	FCC Part 15 Class B, CAN ICES-003(B)/NMB-003(B), EN 55032/CISPR 32 Class B Conducted and Radiated		
	Harmonic Current Emissions	IEC 61000-3-2		
	Voltage Fluctuations & Flicker	IEC 61000-3-3		
	Immunity	EN 55035/CISPR 35: IEC 61000-4-2 (+/- 8kV air, +/-4kV contact), IEC 61000-4-3, IEC 61000-4-4, IEC 61000-4-5 (+/- 1kV), IEC 61000-4-6, IEC 61000-4-8, IEC 61000-4-11		
Mechanical	Dimensions (L x W x H)	103.4mm (4.07in) x 42mm (1.65in) x 28.7mm (1.13in)		
	Weight	140g		
	DC Cord Length	1500mm		
	DC Output Connector	5.5mm x 2.1mm x 10mm center positive		
	DC Plug Pin Assignment	Inner (V+) / Outer GND (V-)		
	Cable Wire Type	24 AWG		
	Input Connector	IEC 60320 C14		
Notes	<ol style="list-style-type: none"> The specifications defined are at ambient temperature of 25°C, unless otherwise specified. Special order MOQ 20MHz bandwidth frequency oscilloscope, add a 0.1µF multilayer Cap. and Low ESR Electrolytic Cap. (10µF) at output connector terminals (nominal line voltage, full load). Efficiency is measured after 30 minutes burn-in. <p>*NRCan approval for PSAC30U-120L6-R, PSAC30U-240L6-R models only</p>			

Phihong is not responsible for any error and reserves the right to make changes without notice. Please visit our website at www.phihong.com for the most up-to-date specifications and contact information.

Dimensional Diagram Unit: mm



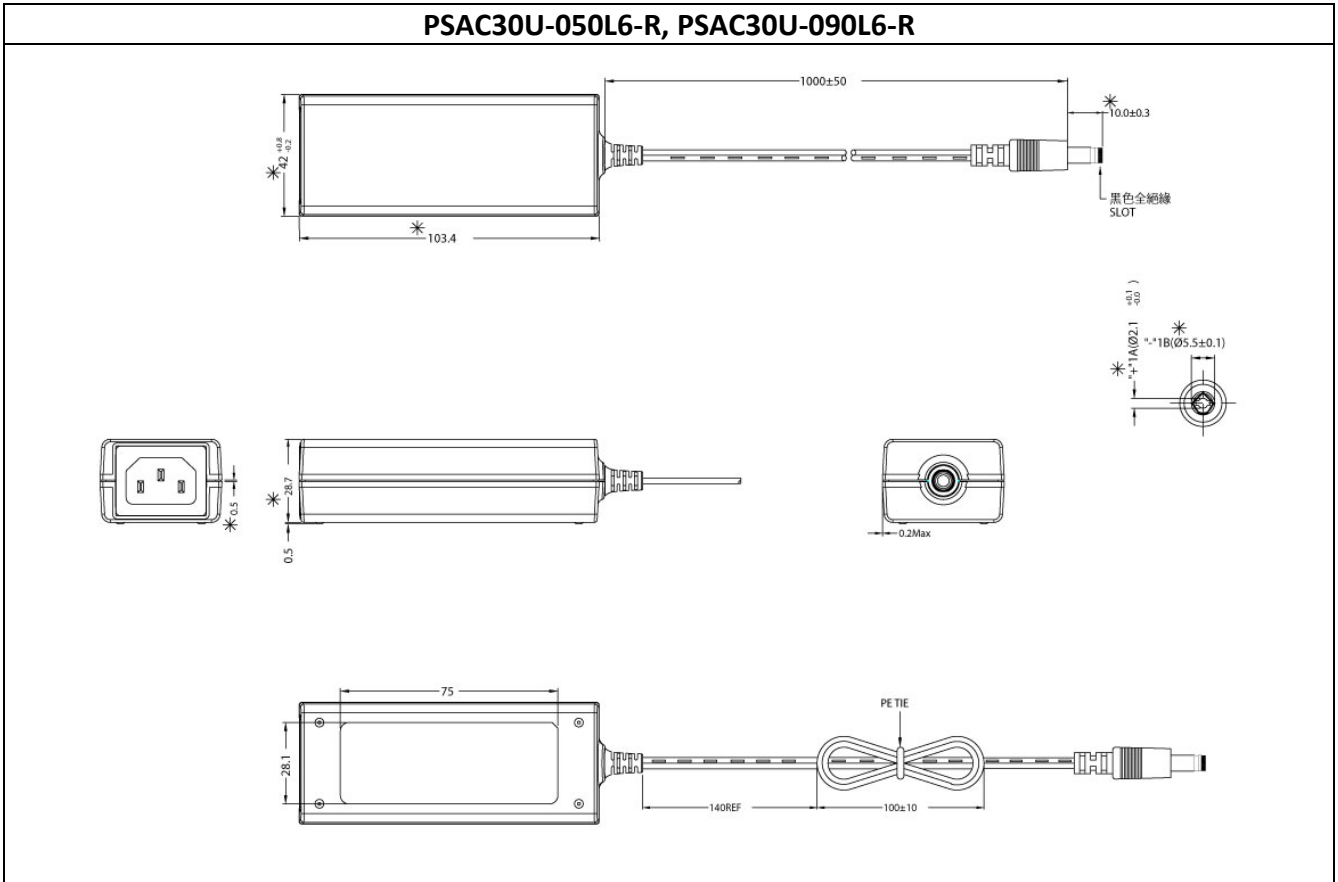

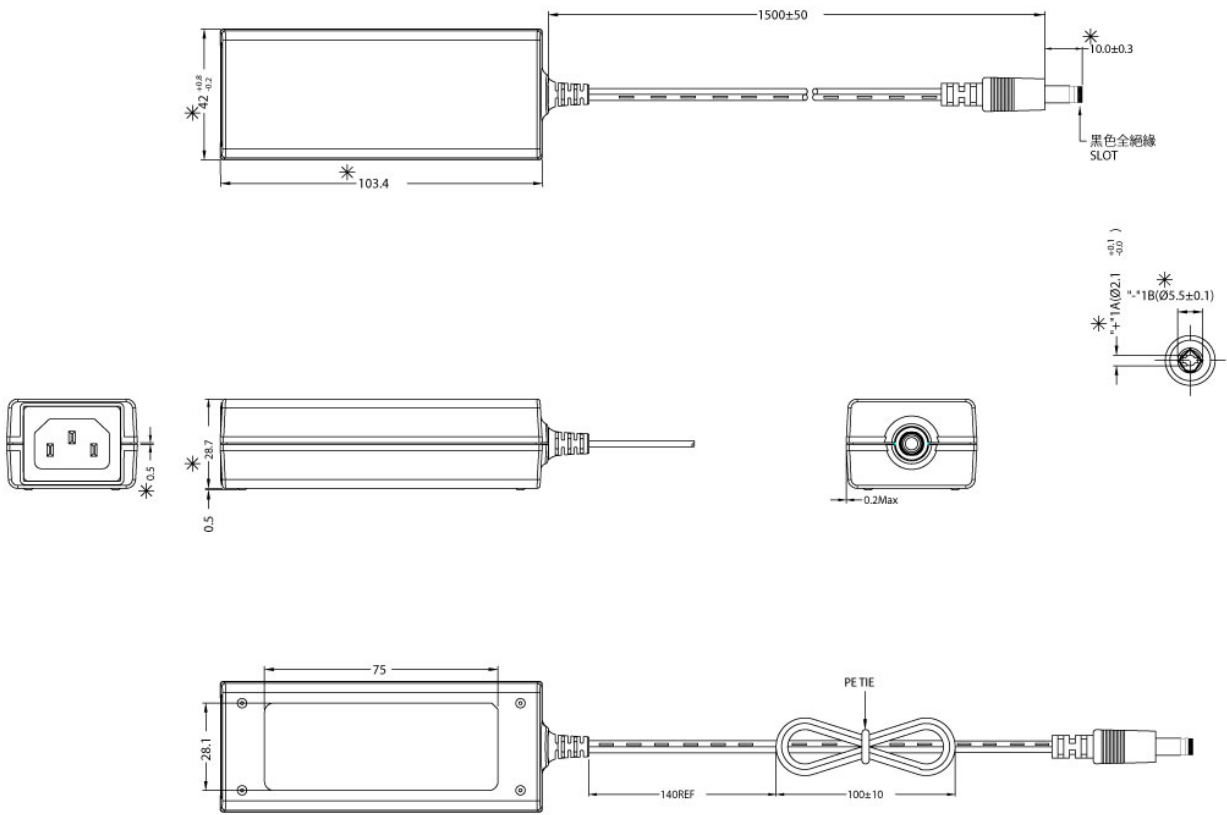

PSAC30U-050L6-R, PSAC30U-090L6-R



PSAC30U-120L6-R, PSAC30U-240L6-R, PSAC30U-480L6-R, PSAC30U-560L6-R



USB Cables - Sold Separately Unit: mm

Model		AC30UNA-R	AC30UNA-R	AC30UNA-R
Specifications	Plug Type	North America NEMA 5-15P	Continental Europe CEE 7VIII	United Kingdom BS 1363
	Connector	IEC320 C13		
	Wire Size	18 AWG	0.75mm	1.0mm
	Temperature	60°C	70°C	70°C
	Amperage Rating	10A	6A	10A
	Voltage Rating	125V	250V	250V
	Cable Length	1830mm	1830mm	2500mm
Safety Approvals		CSA; UL	CEBEC; DEMKO; DVE; FIMKO; GOST; IMQ; KEMA; NEMKO; NF; OVE; SEMKO	BSI; Safety Mark
Photos		 	 	 

USB Cables - Outline Drawings

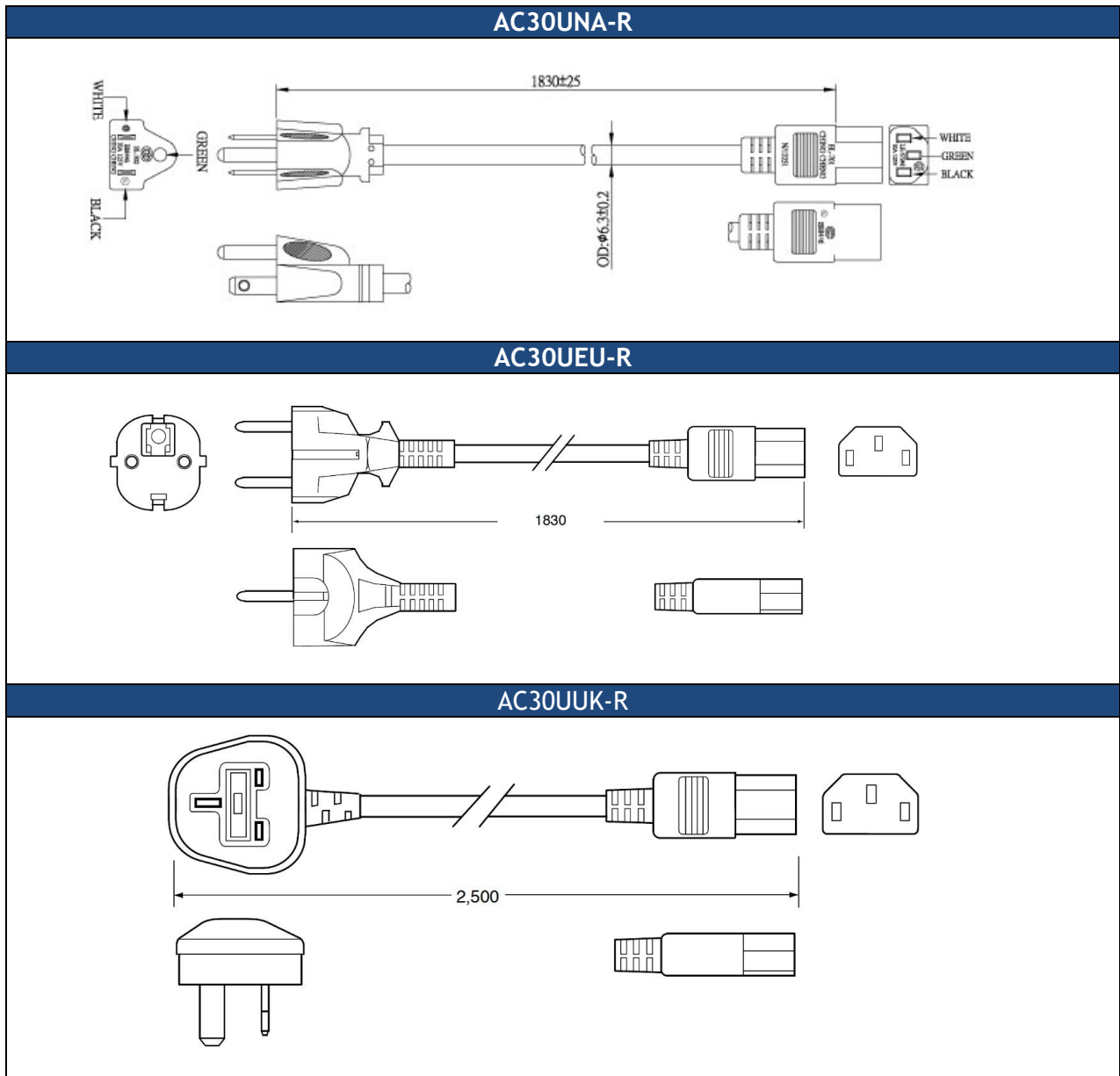

Phihong Locations



Headquarters Phihong Technology Co., Ltd
No. 568, Fuxing 3rd Rd., Gueishan Dist., Taoyuan City (33383), Taiwan
Tel : +886-3-3277288
Fax : +886-3-3277622
phsales@phihong.com.tw
www.phihong.com.tw



Phihong Technology Co. Ltd. (Tainan R&D Center)
No. 99, Zhengnan 1st. Street, Yongkang Dist., Tainan City 71046, Taiwan
Tel : +886-6-254-7588
Fax : +886-6-254-7288
phsales@phihong.com.tw
www.phihong.com.tw



Phihong China
Room 101, Building 5, 133-1 Tiesong Road, Qingxi Town, Dong Guan City, GuangDong(523642), China
Tel : +86-769-87319026
Fax : +86-769-87317106
phsales@phihong.com.tw



Phihong USA
47800 Fremont Blvd., Fremont, CA 94538, U.S.A.
Tel : +1-510-445-0100
Fax : +1-510-445-1678
usasales@phihongusa.com
www.phihong.com



Phihong Japan
PMOEX Nihonbashi Kayabacho 10F, 2-12-10
Nihonbashi Kayabacho, Chuo City, Tokyo 103-0025 Japan
Tel : +81-3-6626-5513
Fax : +81-3-6629-0241
phsales@phihong.com.tw
www.phihong.co.jp



Phihong Vietnam
Lot CN5 An Duong Industrial Zone, Hong Phong Commune,
An Duong County, Hai Phong City, Vietnam
Tel : +84-22588-31557